

Full IP65 Chassis LCD

42" LED(Stainless Design)



Specifications

Model Name	W42L100-65A3
Viewable Size Image	42"
Active Display Area(mm)	930.24 (H) x 523.26 (V)
Pixel Pitch(mm)	0.4845 (H) x 0.4845 (W)
Number of Pixels	1920x1080
Contrast Ratio	4000:1(typ.)
Display Color	16.7M (8bits/color)
Brightness(cd/m ²)	500(typ.)
Viewing Angle(CR>=10)	-89~89 (H); -89~89 (V)
Synchronization Range	
Horizontal/Vertical	47~63KHz / 60~73Hz
Recommended Resolution	1920x1080@60HZ
Signal Connector	10 pin IP65 Connector
I/O	3 pin Power cable(IP65 connector) 10 pin VGA cable(IP65 connector)
Power Source	AC100~240V, Universal, ±10% (IP65 Connector)
Power Consumption	81W typical, normal operation
Power Management	VESA DPMS Compliant
Plug & Play	VESA DDC 1/2B
Optional Touch Screen	No(Glass only)

*Due to Panel material's deviation, different panel supplier will set different specific variance range to optical characteristics. The factors of time used, Lamp current, Ambient temperature will influence the optical measurements.

Mechanical Drawing

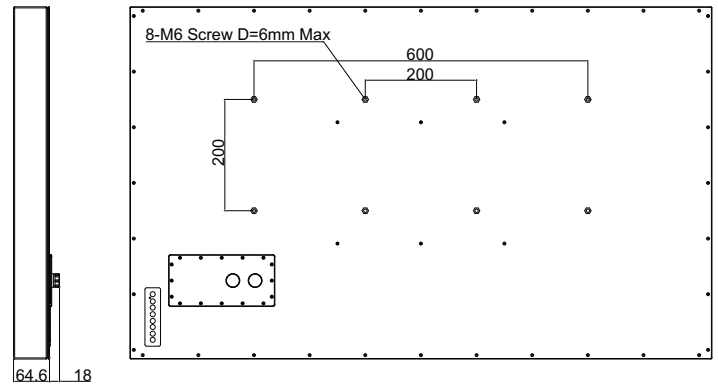
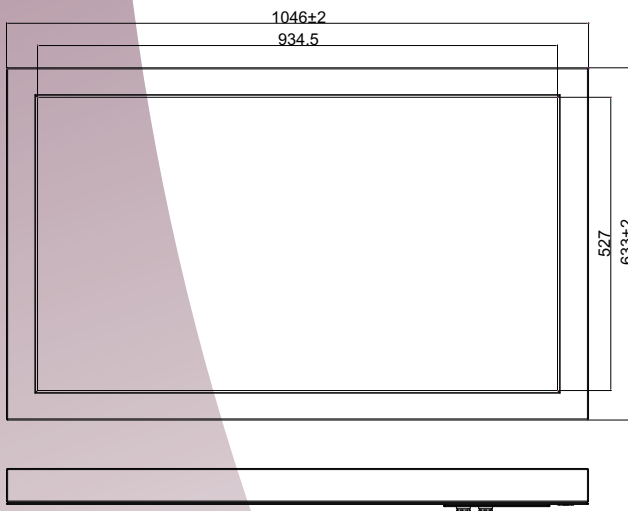

* Note: this is a simplified drawing and some components are not marked in detail. Please contact our sales representative if you need further product information.

Note: All Specifications are subject to change without prior notice!

Full IP65 Chassis LCD

IO Layout

Rear Side (I/O)

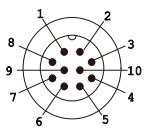

Optional RS232

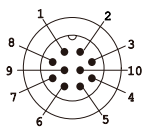

10 pin VGA connector

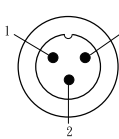

3 pin Power

Cable List

LCD	IP65 connector	PC side IO type
Power Adapter	3pin	Power cord
RS232(optional)	10pin	Female(D-sub 9)
VGA	10pin	Male(D-sub 15)

IP65 Cable/Pin Define

Power Cord

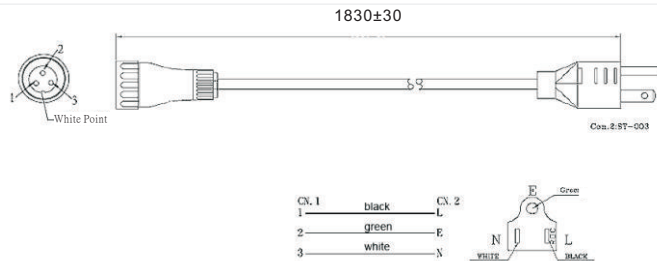

VGA

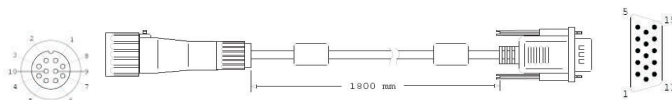

CN1			CN2		
Pin No.	Symbols	Color	Pin No.	Symbols	Color
1	R	Red	1	R	Red
2	R-GND	Black	6	R-GND	Black
3	G	Green	2	G	Green
4	G-GND	Black	7	G-GND	Black
5	B	Blue	3	B	Blue
6	B-GND	Black	8	B-GND	Black
7	SDA	Yellow	12	SDA	Yellow
8	HS	Orange	13	HS	Orange
9	VS	White	14	VS	White
10	SCL	Brown	15	SCL	Brown
			4	HS-GND	
			5	NC	
			9	NC	
			10	NC	
			11	VS-GND	

RS232



Pin No.	Symbols	Color	Pin No.	Symbols	Color
CN1-1	DCD-CON2	Green	CN2-1	DCD-CON2	Green
CN1-2	DSR-CON2	Brown	CN2-6	DSR-CON2	Brown
CN1-3	RXD-CON2	Red	CN2-2	RXD-CON2	Red
CN1-4	RTS-CON2	Orange	CN2-7	RTS-CON2	Orange
CN1-5	TXD-CON2	Blue	CN2-3	TXD-CON2	Blue
CN1-6	CTS-CON2	White	CN2-8	CTS-CON2	White
CN1-7	DTR-CON2	Purple	CN2-4	DTR-CON2	Purple
CN1-8	RI-CON2	Yellow	CN2-9	RI-CON2	Yellow
CN1-9	GND-CON2	Black	CN2-5	GND-CON2	Black
CN1-10	NC		CN2-10	NC	